

(1Δ)

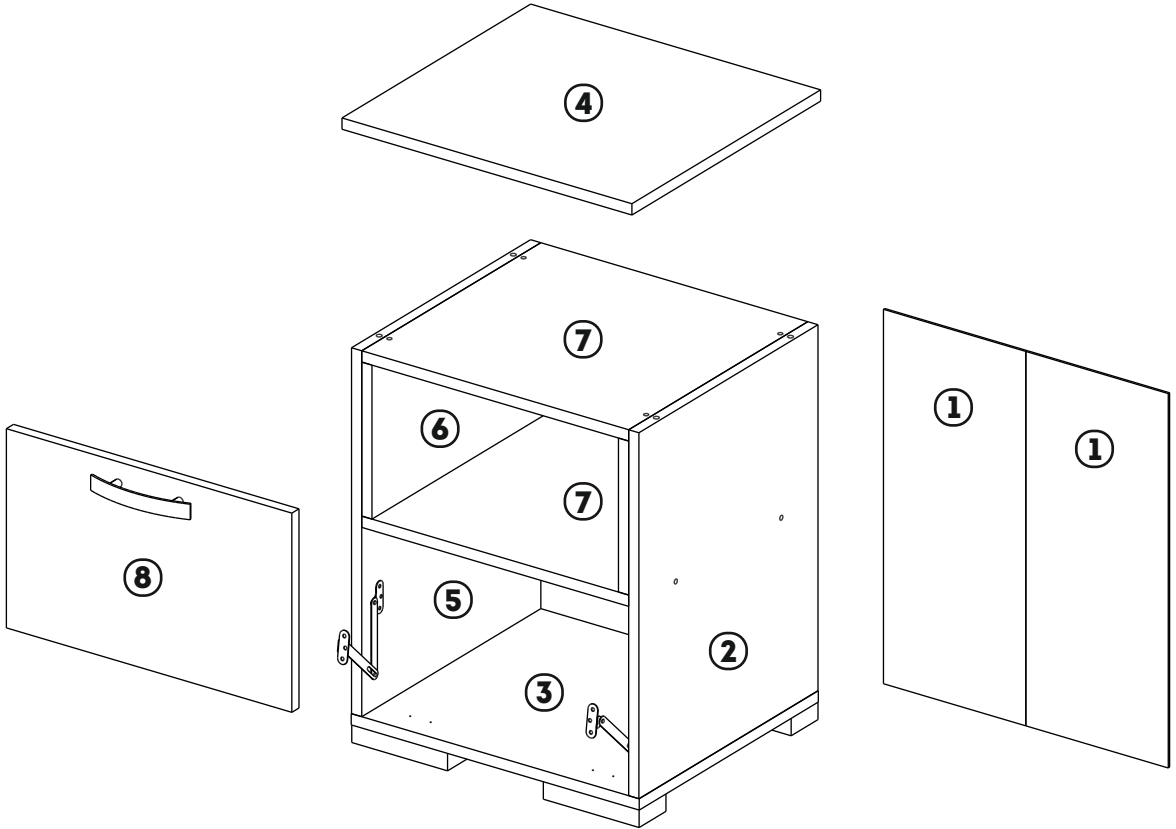

No	a*b	X
1	530x223	2
2	518x401	1
3	451x401	1
4	454x422	1
5	518x401	1
6	218x401	2
7	418x401	2
8	282x447	1

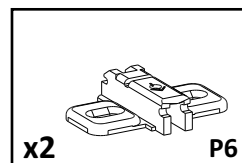

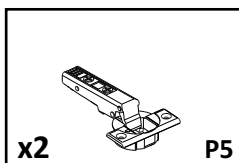
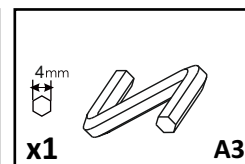
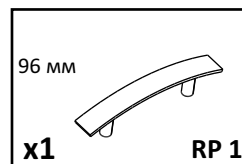
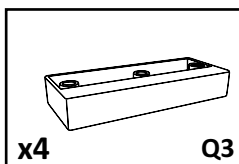
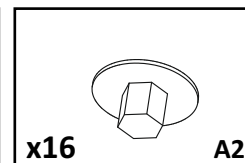
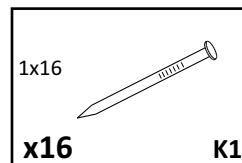
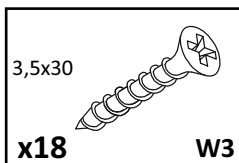
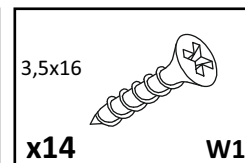
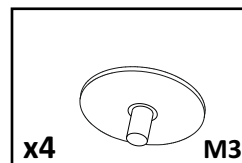
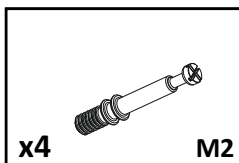
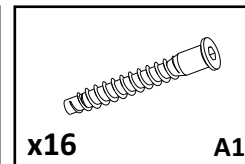
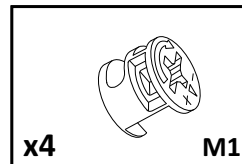
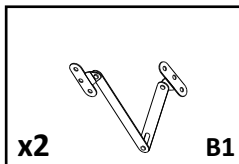
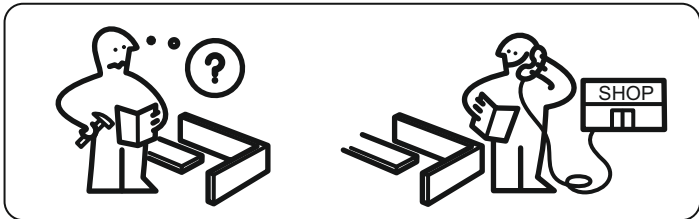
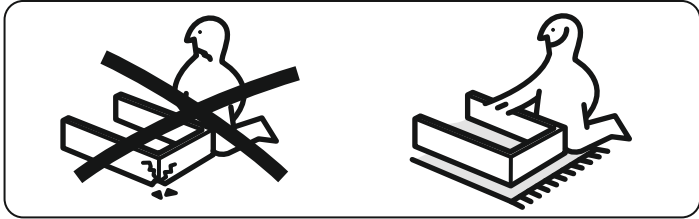
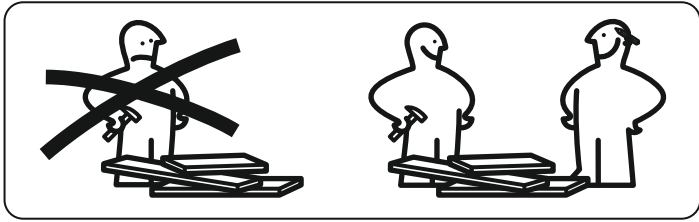

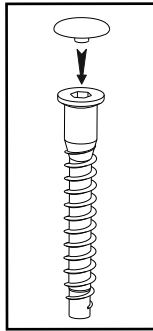
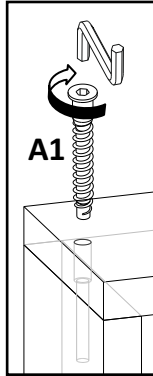
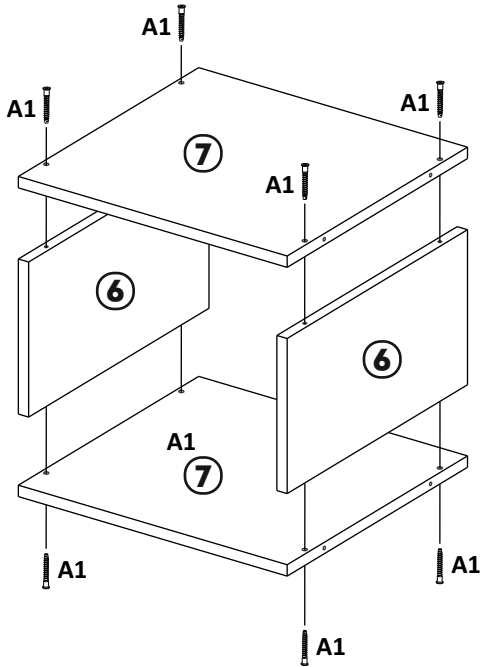
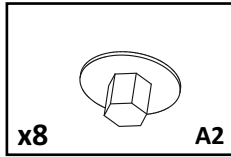
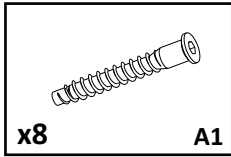
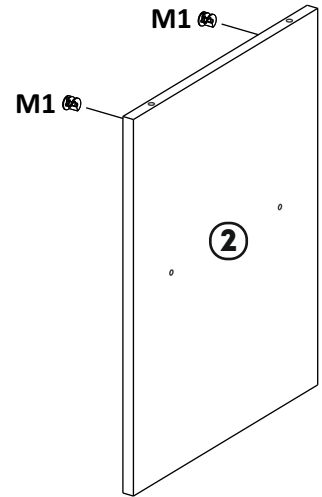
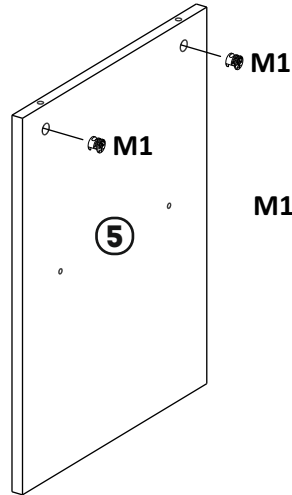
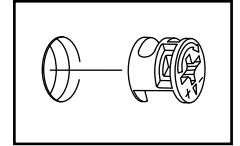
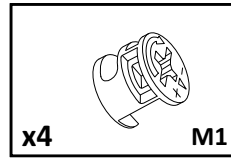
1**2**

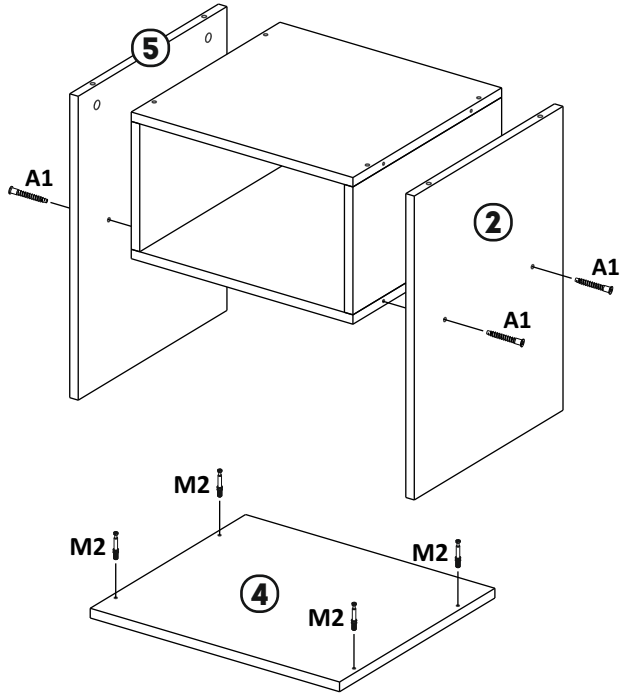
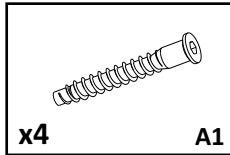
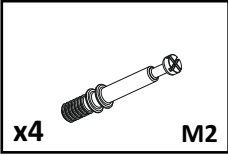
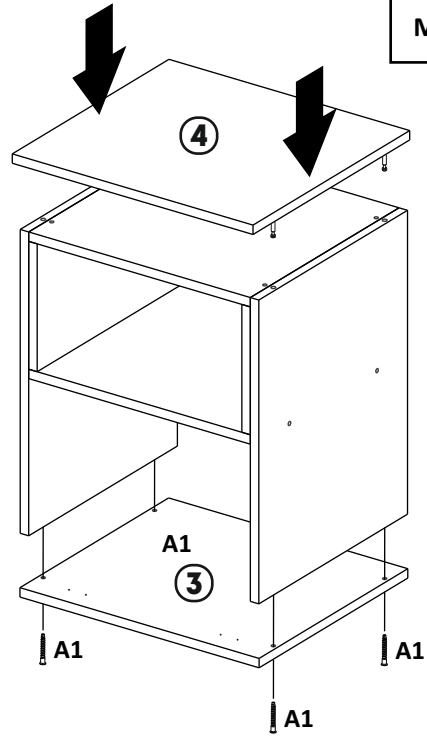
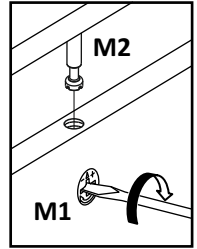
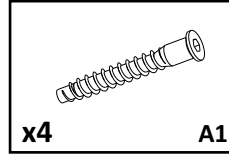
3**4**

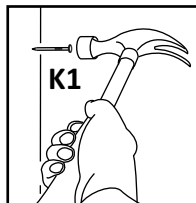
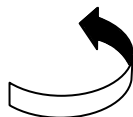
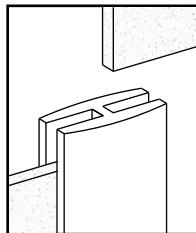
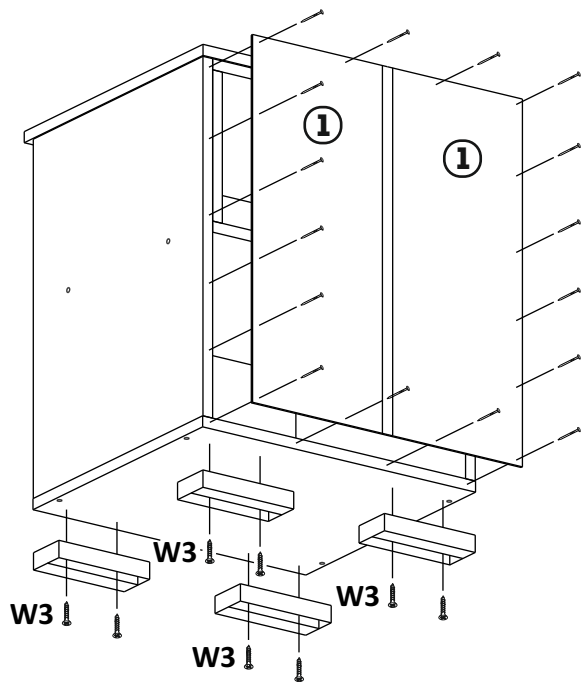
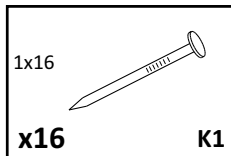
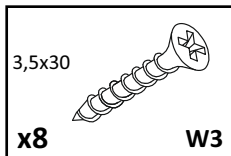
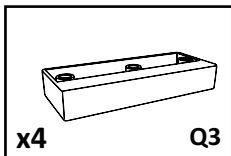
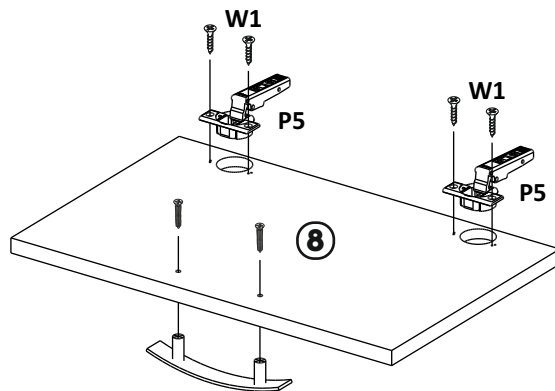
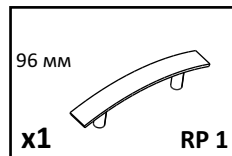
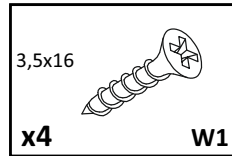
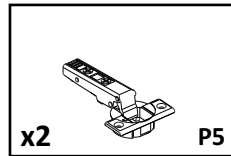
5**6**

7

3,5x16

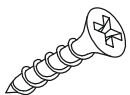
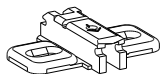
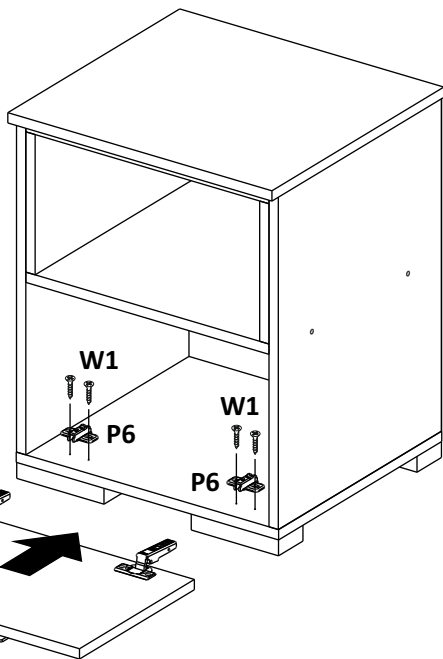
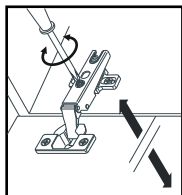
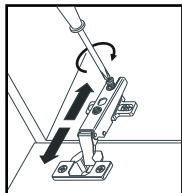
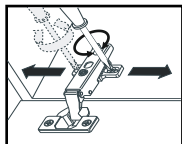
**x4****W1****x2****P6****8**

3,5x16

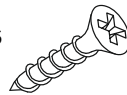
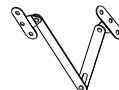
**x8****W1****x2****B1**